

BRAUN

MultiQuick 7



Type HB701A1

Register your product
www.braunhousehold.com/register

Hand blender

RO Vă rugăm să citiți cu atenție și în întregime instrucțiunile de siguranță (broșură separată) înainte de a utiliza aparatul.

Romană (RO/MD)

© Copyright 2023. All rights reserved
De'Longhi Braun Household GmbH
Carl-Ulrich-Straße 4
63263 Neu-Isenburg/Germany

5722170104/12.23

HB701-MQ70xx INT
DE/UK/FR/ES/CA/PT/IT/NL/DK/NO/SE/FI/PL/CZ/SK/HU/HR/
SI/TR/RO/MD/GR/KZ/RU/UA/AR



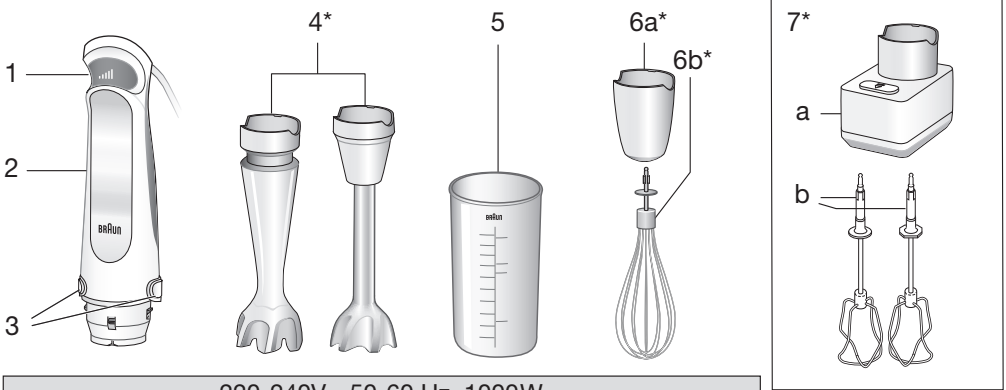

220-240V~ 50-60 Hz 1000W

* certain models only

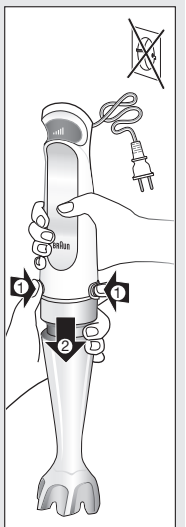
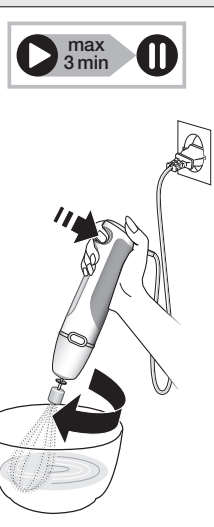
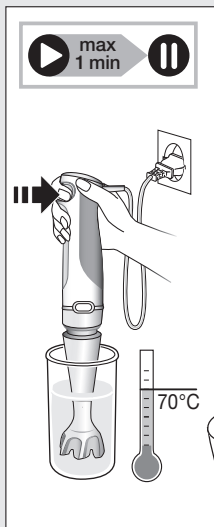
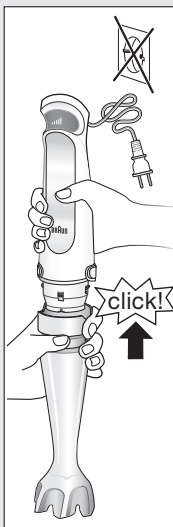
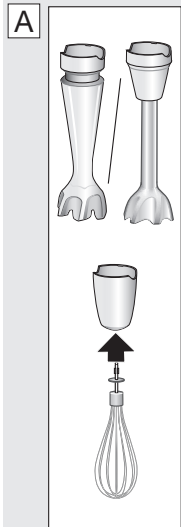
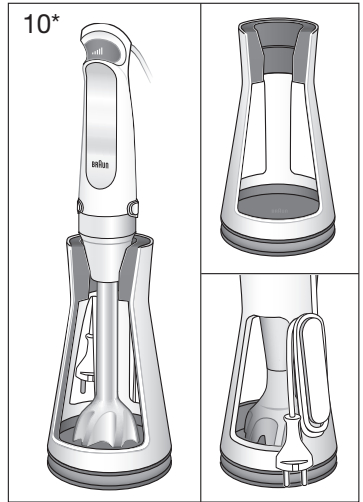
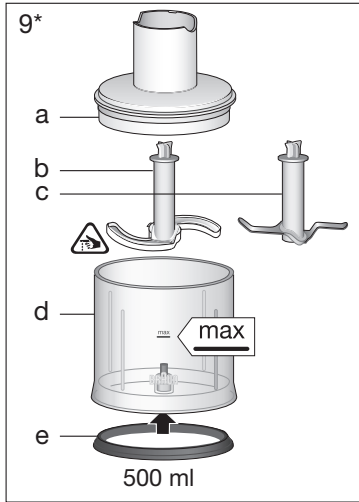
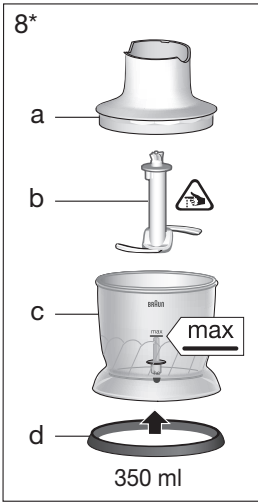



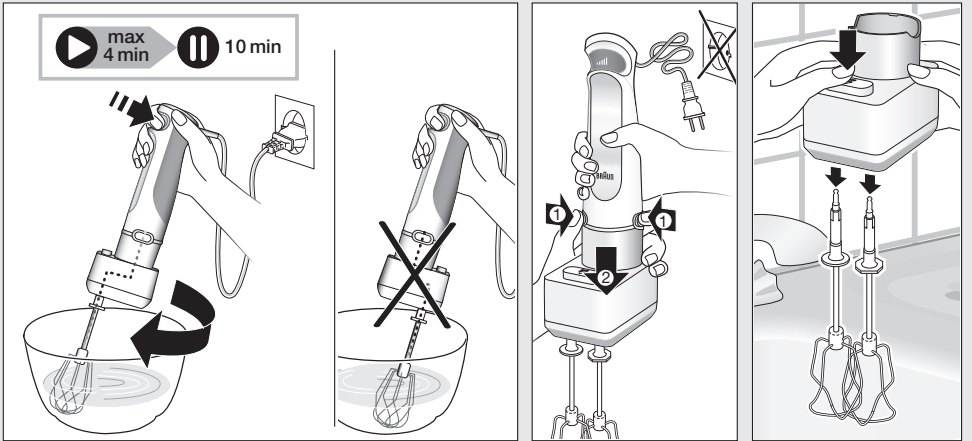
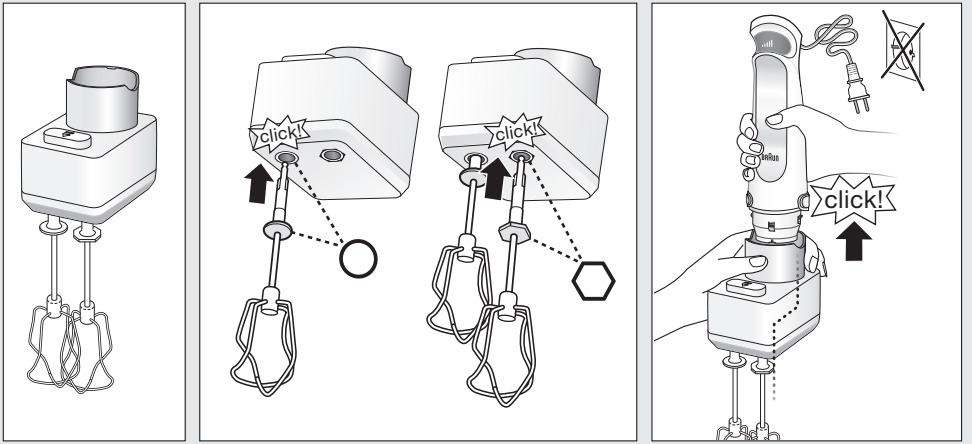





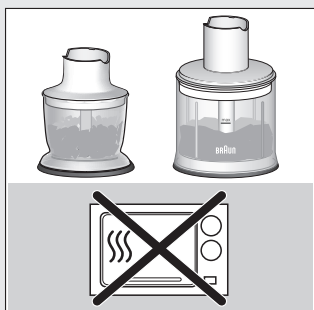
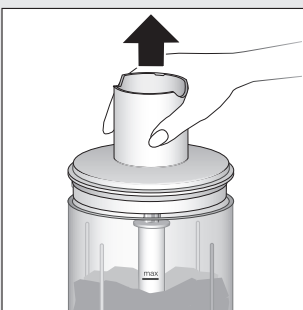
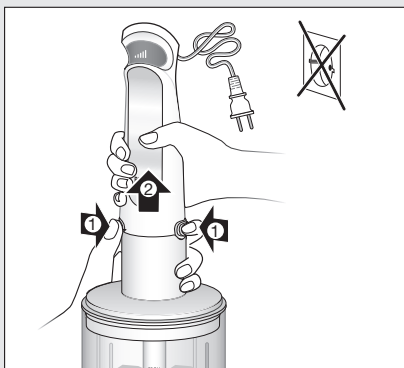
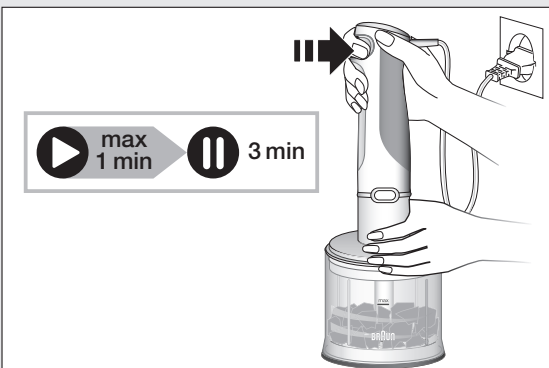
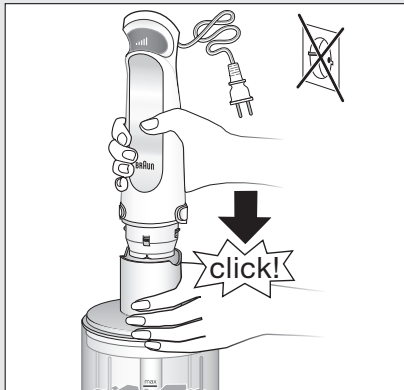
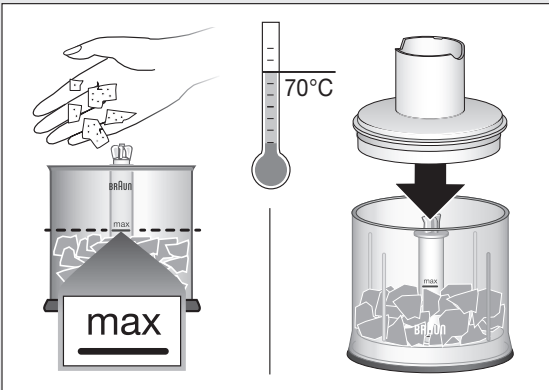
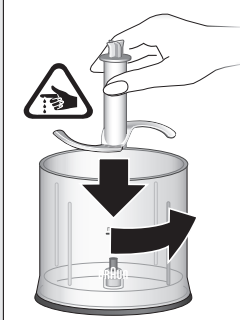
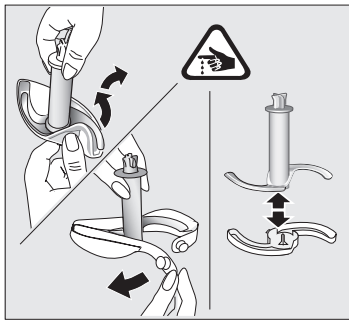
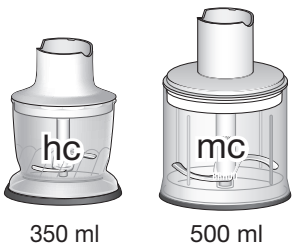













B



























	<p>4...8°C</p> <p>max. 400 ml</p>		<p>15...20°C</p>			<p>< 70°C</p>
max.	400 g	250 g	8	500 g	200 g	1000 g
speed						
	90 s	30 s	3 min	4 min	4 min	3 min

C









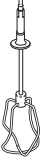

 350 ml			Parmesan 							
		 2 cm	 2 cm					 2 cm		
	max.		100 g	10 g	90g+ 	50 g	7	80 g	80 g	100 g
	speed									
	 sec.		15	5	30	5	5	10	5	10

 500 ml										
			Parmesan 							
		 2 cm	 2 cm				 2 cm			
	max.	300 g	200 g	30 g	200 g	20	200 g	250 g	350 g	5 
	speed									
 sec.	20-30	15-25	10-20	6x1	10-15	10	20	25	12x1	

D

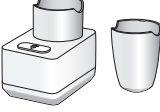

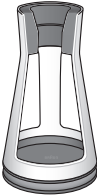
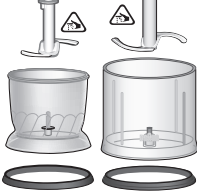
Română (RO/MD)

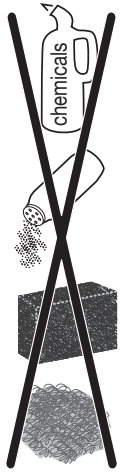
Înainte de utilizare



Vă rugăm să citiți cu atenție și în întregime instrucțiunile înainte de a utiliza aparatul și să le păstrați pentru referință ulterioară.

Îndepărtați toate ambalajele și etichetele și le evacuați ca deșeu în mod corespunzător.

Piese și accesorii

- 1 Buton pentru controlul inteligent al vitezei Smart Speed / viteze variabile
- 2 Motor
- 3 Butoane de declanșare EasyClick Plus
- 4 Axul blenderului
- 5 Cupă
- 6 Accesoriu dispozitiv de bătut

- a Aparat de viteze
- b Dispozitiv de bătut
- 7 **İkili ırpma aksesuarı**
 - a ıkarma dğmeli diŐli kutusu
 - b ırpıcılar
- 8 **Accesoriu tocător de 350 ml «hc»**
 - a Capac
 - b Lamă de tocare
 - c Castron tocător
 - d Inel anti-alunecare din cauciuc
- 9 **Accesoriu tocător de 500 ml «mc»**
 - a Capac (cu angrenaj)
 - b Lamă de tocare
 - c Lamă pentru gheață
 - d Castron tocător
 - e Inel anti-alunecare din cauciuc
- 10 Stativ pentru depozitare

Axul blenderului (A)

Blenderul de mână este perfect adecvat pentru prepararea legumelor pasate, a sosurilor, a sosurilor pentru salate, a supelor, a hranei pentru bebeluŐi, precum Ői a băuturilor, a celor de tip smoothie Ői milkshake.

Pentru cele mai bune rezultate folosiŐi viteza cea mai mare.

Pentru instrucŐiuni detaliate de procesare consultaŐi secŐiunea A.

Accesoriu dispozitiv de bătut (A)

FolosiŐi dispozitivul de bătut numai pentru friŐcă, spumă de albuŐ, pandiŐpan Ői deserturi semipreparate.

Pentru cele mai bune rezultate folosiŐi viteza cea mai mare.

Pentru instrucŐiuni detaliate de procesare consultaŐi secŐiunea A.

İkili ırpma aksesuarı (B)

UtilizaŐi paleta dublă numai pentru aluat de prăjituri, smântână, albuŐuri de ou Ői cartofi piure. Nu folosiŐi accesoriul pentru aluaturi groase Ői pentru frământarea aluaturilor pentru pizza, paste, pâine sau a aluaturilor fragede.

Capacul (5) nu trebuie utilizat cu accesoriul cu paletă dublă.

Pentru instrucŐiuni detaliate de procesare consultaŐi secŐiunea B.

Accesoriu tocător (C)

Tocătoarele (8/9) sunt perfect adecvate pentru a toca brânză tare, ceapă, ierburi, usturoi, legume, pâine, biscuiŐi Ői nuci.

Nu folosiŐi accesoriile tocătorului (8/9) cu lame tocătoare la prepararea alimentelor foarte tari, precum nuci întregi, cuburi de gheață, boabe de cafea, grăunțe sau condimente tari, ca de exemplu nucșoară. Prepararea acestor alimente ar putea deteriora lamele.

Pentru tocătorul «hc» Ői «mc» nu depăŐiŐi linia de max la cantitatea de ingrediente.

Oprii imediat prepararea dacă viteza motorului scade Ői/sau dacă apar vibraŐii puternice.

Numai accesoriul tocător «mc» (9), cu lamă specială pentru gheață (9c) este permis pentru zdrobirea cuburilor de gheață.

Pentru instrucŐiuni detaliate de procesare consultaŐi secŐiunea C.

«hc» Exemplu de reŐetă: Prune uscate cu miere (ca umplutură de clătite sau sos de ornat)

50 g prune uscate

75 g miere cremoasă

70 ml de apă (aromată cu vanilie)

- UmpleŐi castronul tocătorului «hc» cu prune uscate Ői miere cremoasă.
- ȚineŐi la 3 °C în congelator timp de 24 de ore.
- AdăugaŐi 70 ml de apă (aromată cu vanilie).
- TocaŐi timp de 1,5 secunde la viteză maximă (apăsăŐi butonul pentru controlul inteligent al vitezei Smartspeed până la capăt).

İngrijire Ői curăŐare (D)

Pentru informaŐii detaliate consultaŐi secŐiunea D.

GaranŐie Ői service

Pentru informaŐii detaliate vezi broŐura separată de garanŐie Ői service sau vizitaŐi www.braunhousehold.com.

Nu aruncaŐi produsul împreună cu deŐeurile menajere la sfârŐitul ciclului de viață al acestuia. Produsul poate fi remis la un centru de service Braun sau la un punct de colectare corespunzător din țara dvs.



Materialele Ői obiectele destinate contactului cu produsele alimentare sunt în conformitate cu dispoziŐiile regulamentului European 1935/2004.



Instrucțiuni de depanare

Problemă	Cauze posibile	Soluție
Amestecătorul manual nu funcționează.	Nu este energie	Verificați aparatul să fie în priză. Verificați siguranța / disjunctorul din casa dvs. Dacă nu este nici unul din cazurile de mai sus, contactați serviciul clienți Braun.
Paletele huruie sau se ating în timpul funcționării	Paletele s-au blocat	Scoateți și reintroduceți paletele